



## KITCHEN SOLUTIONS

Modern integration of power for kitchens

It's electric.

**BACH  
MANN**

# Plug into a world of opportunities

The new BACHMANN power strips for kitchens are the result of years of experience and skilled German engineering. Combined with high-quality materials and collaborations with well-known product designers, this makes our power strips designer pieces for perfect power integration. With BACHMANN KITCHEN SOLUTIONS you can be sure of having access to the best connectors and connections. Our products are configurable with numerous standard international socket outlets and if necessary with data connections too. Get in touch. We are happy to assist with customised solutions and projects.

**NEW DUE..... 6**

Award-winning power strip with an interchangeable cover that allows it to be integrated elegantly into its surroundings.



**NEW PIX..... 8**

Versatile, minimalist connector units with interchangeable decorative rings to add a touch of colour.



**NEW KAPSA..... 10**

Power strip with modular equipment options, ideal for use in the kitchen thanks to its protective flip-open cover.



**TWIST..... 12**

Exceptionally compact power strip with low installation depth. TWIST is flat enough not to interfere with units installed underneath.



**ELEVATOR..... 14**

Designed for a standard hole diameter of 80 mm, ELEVATOR is a compact powerhouse with up to three socket outlets. Recessed in the top of the work surface when not in use, simply touch to raise.



**ELEVATOR COVER..... 16**

The housing for ELEVATOR for fitting on walls, in corners or directly in cabinets.



**NEW SMART PLUG / FLAT PLUG ..... 18**

Allows power to be used in very tight spaces. Suitable for all common flush-mounted socket outlet systems, these flat plugs are ideal for use behind cabinets and appliances.



**CASIA..... 20**

Universal multiple-socket outlets for installing both in corners and on walls.

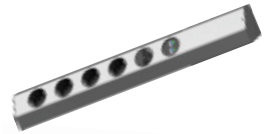

**POWER FRAME..... 22**

For the integrated power connection. Versatile application options. The power strip simply clicks into the built-in frame.



**POWER FRAME COVER ..... 24**

The amazing evolution of the POWER FRAME – an elegant and attractive cover that is particularly suitable for stylish kitchens.



**CONI..... 26**

Free access to the power supply. The integrated brush insert prevents cables from getting trapped.

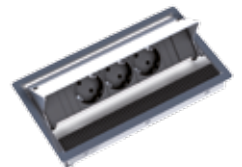

**LIFT ..... 28**

A highly practical combination of sophisticated looks and precision mechanical design which can also be recessed.



**Accessories and assembly items ..... 30**



# World of opportunities



## Function modules can be integrated ex factory



### Overvoltage protection

These days the failure of electrical and electronic equipment is a real nightmare scenario. Protection against excess electric voltage is more important than ever for electrical and electronic equipment. "24/7 availability" is now essential for many users. Don't worry: the BACHMANN strip with built-in overvoltage protection is the answer.

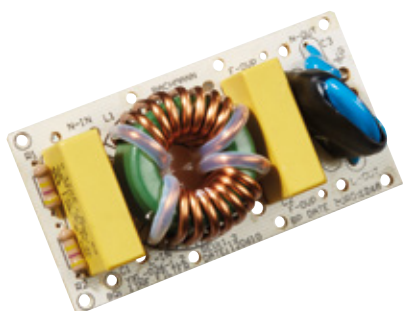

### Mains and frequency filters

Mains and frequency filters ensure effective screening and smoothing of the input voltage. Only "clean" voltage gets through our mains and frequency filters. Voltage stabilisation and the filtering out of disturbance frequencies allows the connected device to run properly and smoothly.



### USB 3.0 keystone module

The USB keystone module supports USB 3.0 and allows data to be transferred at high speed. Three different socket/socket combinations are available for different configurations.

### USB charger

The USB charger component has two ports with max. 2.15 A. Integrated in BACHMANN products, the ability to charge mobile devices using the universal USB charger is very convenient and the integrated mains adaptor frees up socket outlets too.

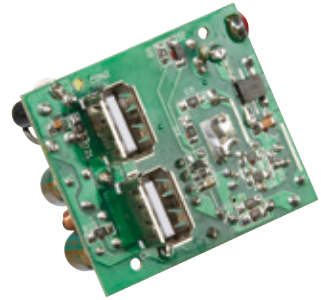

### Residual current circuit breaker / miniature circuit breaker

The residual current circuit breaker / miniature circuit breaker integrated in a Bachmann strip gives you peace of mind. The user can select between the two circuit breakers. But they can of course be combined too.

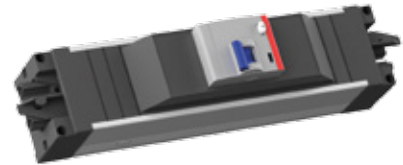

Configure your individual BACHMANN product at [www.bachmann.com](http://www.bachmann.com)





DESIGN PLUS

powered by: **light** building

INNOVATIONSPREIS

ARCHITEKTUR+TECHNIK

**NEW**

# DUE

## Form and function in a duet

DUE is the ideal power strip for the kitchen. It guarantees an elegant power connection and can be used just as effectively in the office as in other areas. With its interchangeable covers, it can be colour-coordinated to its surroundings or create accents as desired, even after installation.

The split cover allows DUE to be slid open as required, with a design that looks equally elegant when in use. The low installation depth of approximately 45 mm allows it to be compactly integrated into kitchen worktops or the wall or installed above drawers.

The benefits at a glance

- Interchangeable covers available in black, white and stainless steel look
- Low installation depth (approx. 45 mm)
- Space-saving even when open
- Supplied with mounting template
- Integrated water run-off

DUE power strips

NEW

Article no. | Version

**DUE 2 x socket outlets with earthing contact**

Housing, black plastic; power input 2.0 m cable with end sleeves and included mounting plug, black  
 929.000 | · 2 x socket outlets with earthing contact, shuttered, black, set at 90°



**DUE 2 x UTE**

Housing, black plastic; power input 2.0 m cable with end sleeves and included mounting plug, black  
 929.002 | · 2 x French/UTE socket outlets, shuttered, black, set at 90°



**DUE 2 x UK**

Housing, black plastic; power input 2.0 m cable with mounted mounting plug (13A), black  
 929.004 | · 2 x UK socket outlets, shuttered, black, set at 90°



**!** Housing only, cover must be ordered separately

DUE cover

Article no. | Version

**DUE cover Stainless steel look**

Available from 2nd / 3rd quarter

929.100 | · Made from plastic, stainless steel look finish  
 · Contents: 2 x covers

**DUE cover, black**

929.101 | · Made from plastic, colour black, similar to RAL9005  
 · Contents: 2 x covers

**DUE cover, white**

929.102 | · Made from plastic, colour white, similar to RAL9010  
 · Contents: 2 x covers



DUE power strip

The low installation depth of approximately 45 mm allows it to be compactly integrated into kitchen worktops or installed above drawers.

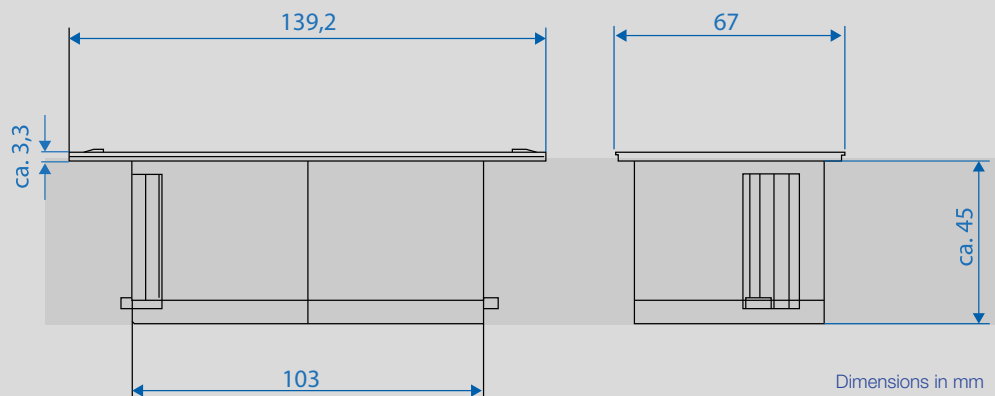

**NEW**

## PIX

Design exactly where you need it

The stylish PIX range is a collection of sophisticated, round socket outlet and connector units that can be used in many different ways – in the office, kitchen, public lounge or at home.

Used alone or in your chosen combination, the decorative rings are available in various colours and can be interchanged. An ingenious, swivel-mounted cover, providing protection from dust and dirt, is available as an option for PIX and can also be retrofitted.

With its round, flat shape and minimalist appearance, the PIX meets design requirements exactly where you need it.

### The benefits at a glance

- Can be integrated on its own or in your chosen combination
- Interchangeable, coloured decorative rings
- Small diameter of 55 mm
- With swivel-mounted cover as an option
- Simple mounting from above, retrofitting possible too



PIX power strips

NEW

Article no. | Version

**PIX 1 x socket outlet with earthing contact**

Housing, black plastic; power input 2.0 m cable with end sleeves and included mounting plug, black

- 926.001
- 1 x socket outlet with earthing contact, shuttered, black
  - Mounted decorative ring in black, similar to RAL9005
  - With decorative ring included in white, similar to RAL9010
  - With decorative ring included in stainless steel look



**PIX 1 x UTE**

Housing, black plastic; power input 2.0 m cable with end sleeves and included mounting plug, black

- 926.003
- 1 x French/UTE socket outlet, shuttered, black
  - Mounted decorative ring in black, similar to RAL9005
  - With decorative ring included in white, similar to RAL9010
  - With decorative ring included in stainless steel look



**PIX 1 x UK**

Housing, black plastic; power input 2.0 m cable with mounted mounting plug (13 A), black

- 926.007
- 1 x UK socket outlet, shuttered, black
  - Mounted decorative ring in black, similar to RAL9005
  - With decorative ring included in white, similar to RAL9010
  - With decorative ring included in stainless steel look



PIX cover set

Available from 3rd quarter

Article no. | Version

**PIX cover set, black**

- 926.101
- Swivelling cover with accompanying decorative ring, black, similar to RAL9005
  - Includes panels for respective country and connection versions

**PIX cover set, white**

- 926.102
- Swivelling cover with accompanying decorative ring, white, similar to RAL9010
  - Includes panels for respective country and connection versions



**!** Other colour versions available on request

PIX

The compact form (H x Ø: approx. 50 x 68 mm) and low installation depth (approx. 45 mm) ensure a space-saving installation from above or the front. Retrofitting is also possible.

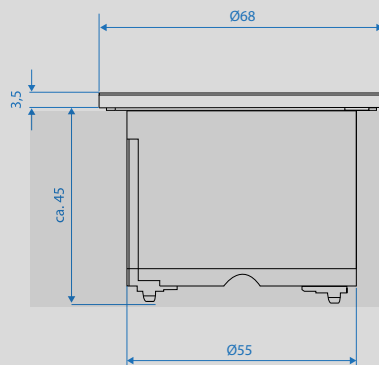

Dimensions in mm

**NEW**

## KAPSA

### Modularity and minimalism combined

KAPSA's classical, reduced lines make it a power strip that is both design-orientated and space-saving – designed for the kitchen, office and many other areas.

The cover – which can be flipped open and interchanged – provides protection against external influences and is available in several versions. Three-way, modular equipment options, thereby allowing flexible configuration.

Installation from above guarantees simple mounting – also optionally available as a retrofitted solution. A low installation depth of approx. 45 mm and a solid design characterise KAPSA and confirm the well-worn saying: less is more.

#### The benefits at a glance

- Easily interchangeable cover available in various versions
- Three-way, modular equipment options
- Aluminium cover with high-quality feel
- Low installation depth (approx. 45 mm)
- Simple mounting from above, retrofitting possible too

KAPSA power strips

**NEW**

**KAPSA; 3-way: Power socket outlets** Length: approx. 204 mm

Aluminium profile, anodised, power input 2.0 m cable with end sleeves and mounting plug, black		
927.000	· 3 x socket outlets with earthing contact, shuttered, black, set at 35°	
927.003	· 3 x UTE/French socket outlets, shuttered, black, set at 35°	
927.006	· 3 x UK socket outlets, shuttered, black, set at 90° , with mounted mounting plug (13A)	
927.009	· 3 x Swiss / CH T13 socket outlet incl. fuse, black, set at 0°	



**KAPSA; 3-way: Power socket outlets + 1 x USB double charger (5.2 V/2.15 A)** Length: approx. 204 mm **U**

Aluminium profile, anodised, power input 2.0 m cable with end sleeves and mounting plug, black		
927.001	· 2 x socket outlets with earthing contact, shuttered, black, set at 35°	
927.004	· 2 x UTE/French socket outlets, shuttered, black, set at 35°	
927.010	· 2 x Swiss / CH T13 socket outlet incl. fuse, black, set at 0°	



**KAPSA; 3-way: Power socket outlets + 1 x USB double charger (5.2 V/2.15 A) + 1 x custom module** Length: approx. 204 mm **U C**

Aluminium profile, anodised, power input 2.0 m cable with end sleeves and mounting plug (13A), black		
927.007	· 2 x UK socket outlets, shuttered, black, set at 90°	

**KAPSA; 3-way: Power socket outlets + 1 x custom module** Length: approx. 204 mm **C**

Aluminium profile, anodised, power input 2.0 m cable with end sleeves and mounting plug, black		
927.002	· 2 x socket outlets with earthing contact, shuttered, black, set at 35°	
927.005	· 2 x UTE/French socket outlets, shuttered, black, set at 35°	
927.008	· 2 x UK socket outlets, shuttered, black, set at 90° , with mounted mounting plug (13A)	
927.011	· 2 x Swiss / CH T13 socket outlet incl. fuse, black, set at 0°	



**!** Housing only, cover must be ordered separately

KAPSA covers

Article no.	Version
<b>KAPSA cover, stainless steel look</b>	
927.100	· Made from aluminium, in stainless steel look
<b>KAPSA cover, black</b>	
927.101	· Made from aluminium, painted black, similar to RAL9005
<b>KAPSA cover, white</b>	
927.102	· Made from aluminium, painted white, similar to RAL9010
<b>KAPSA cover, silver grey</b>	
927.103	· Made from silver grey anodised aluminium, E6/EV1



**!** Other colour versions available on request

KAPSA  
Power strip

A low installation depth of approx. 45 mm and a solid design characterise KAPSA.

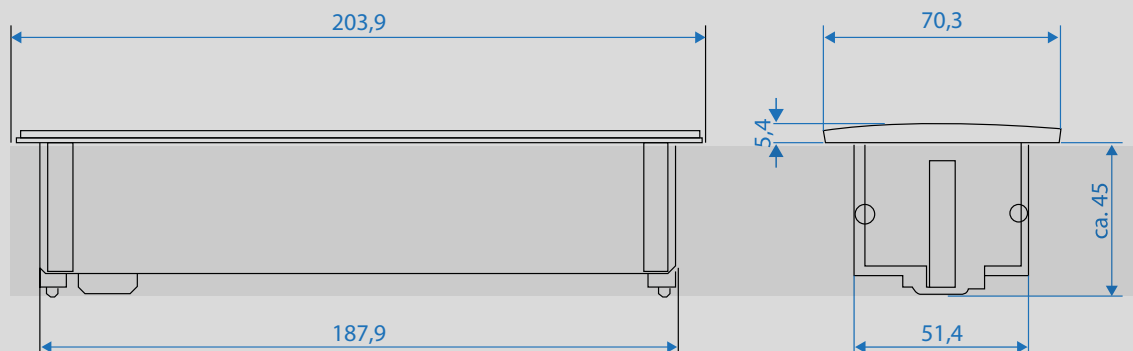

Dimensions in mm

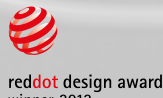
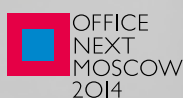

## TWIST

### Power outside the box



TWIST is a power strip for the kitchen, office, lounge and additional, personalised uses. With its compact design and low installation depth, TWIST is easily integrated in a space-saving way into kitchen worktops or desks, for example. Because the power cable is routed close to the housing, the installation depth is only around 40 mm, so the unit can be easily installed above a drawer.

Various surface versions allow TWIST to fit effortlessly into classical, modern concepts – in addition to lively shape and colour concepts. After use, simply rotate the cover and the socket outlets disappear underneath it.

TWIST has achieved national and international renown with its outstanding aesthetics and design. This BACHMANN product has already won numerous prestigious design awards.

#### The benefits at a glance

- Sophisticated twisting lock
- Low installation depth (approx. 40 mm)
- Compact design (H x Ø: approx. 42.5 x 115 mm)
- Space-saving cable routing
- Quick and easy to install

## TWIST

### TWIST

Article no. | Version

#### **TWIST 2S** black, similar to RAL9005 **NEW**

2.0 m cable with end sleeves and black mounting plug, included

931.100	· 2 x socket outlet with earthing contact, shuttered, black	
931.102	· 2 x French/UTE socket outlet, shuttered, black	

#### **TWIST 2S** white, similar to RAL9010 **NEW**

2.0 m cable with end sleeves and black mounting plug, included

931.200	· 2 x socket outlet with earthing contact, shuttered, black	
931.202	· 2 x French/UTE socket outlet, shuttered, black	

Article no. | Version

#### **TWIST 2S** Metallic stainless steel look cover disc

Power input: 2.0 m cable with end sleeves and black mounting plug, included

931.000	· 2 x socket outlet with earthing contact, shuttered, black	
931.002	· 2 x French/UTE socket outlet, shuttered, black	
931.008	· 2 x T23 CH socket outlet, shuttered, black	

#### **TWIST 1S 2P** Metallic matt chrome look cover disc

Power input: 0.2 m with GST18i3 plug

931.001	· 1 x socket outlet with earthing contact, shuttered, black · 2 x keystone mount for data sockets	
931.003	· 1 x French/UTE socket outlet, shuttered, black · 2 x keystone mount for data sockets	
931.009	· 1 x T13 CH socket outlet, shuttered, black · 2 x keystone module for data sockets	

Power input: 2.0 m cable with end sleeves and black mounting plug, included

931.021	· 2 x socket outlet with earthing contact, shuttered, black	
931.016	· 2 x French/UTE socket outlet, shuttered, black	

**!** Other colour versions available on request



### Accessories

#### **Hole saw** diameter: 105 mm

For fitting TWIST

931.900	· In wood/plastic with cutting depth up to 44 mm
918.900	· Mounting tool for hole saw with centring drill

Article no. | Length | Version

#### **Device supply cable, GST18/right-angled earthing contact plug** black

375.003	3.0 m	· Cable: H05VV-F 3G 1.5 mm <sup>2</sup>
375.007	5.0 m	· End 1: Right-angled earthing contact plug / End 2: Wieland GST18i3 socket



TWIST is so compact that it can be easily installed above a drawer.

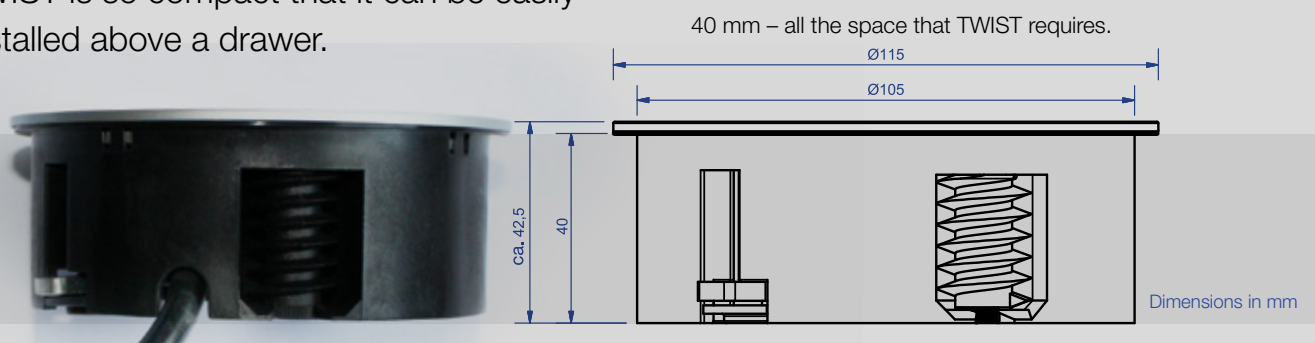



## ELEVATOR

### The compact socket tower

ELEVATOR fits perfectly in any kitchen. Designed for the particular requirements of kitchens, ELEVATOR's 79 mm diameter makes it especially suitable for installation in kitchen worktops. The design is unobtrusive and the materials high quality.

Press down with your finger to raise ELEVATOR, which provides up to three socket outlets in a very small space. The power strip is simply lowered again after use.



Suitable for: The ELEVATOR installation film at [www.bachmann.com](http://www.bachmann.com)

#### The benefits at a glance

- Press down with your finger to raise
- up to 3 socket outlets
- Suitable for standard 79 mm hole
- Quick and easy to install
- Suitable for retrofitting
- Classic design

ELEVATOR socket tower

Article no. | Version

ELEVATOR power strip	
Stainless steel look profile, power input: 2.0 m H05VV-F 3G 1.5 mm <sup>2</sup> with end sleeves and included mounting plug	
928.002	· 2 x socket outlet with earthing contact, shuttered, black
928.003	· 1 x socket outlet with earthing contact, shuttered, black · 2 x Euro socket outlet, shuttered, black
928.007	· 2 x French / UTE socket outlet, shuttered, black
928.017	· 1 x socket outlet with earthing contact, shuttered, 1 x USB double charger (5.2 V / 2.15 A)
928.020	· 1 x French / UTE socket outlet, shuttered, 1 x USB double charger (5.2 V / 2.15 A)
928.024	· 2 x Swiss / T23 socket outlet, shuttered, with mounting plug (included), black
928.046	· 1 x UK socket outlet, shuttered, black, set at 90°, with mounted mounting plug (13A) · 1 x USB double charger (5.2 V / 2.15 A)



ELEVATOR power strip	
Aluminium profile, matt chrome, power input: 0.5 m H05VV-F 3G 1.5 mm <sup>2</sup> with GST18 plug; 3.0 m data cables and plug and/or socket	
928.004	· 1 x socket outlets with earthing contact, shuttered, black, set at 35° · 2 x CAT6 RJ45 with 3.0 m data cable and RJ45 plug
928.005	· 1 x socket outlets with earthing contact, shuttered, black, set at 35° · 1 x CAT6 RJ45 with 3.0 m data cable and RJ45 plug · 1 x USB 3.0 A socket with 3.0 m data cable and USB 3.0 A plug
928.008	· 1 x French/UTE socket outlets, shuttered, black, set at 35° · 2 x CAT6 RJ45 with 3.0 m data cable and RJ45 plug
928.009	· 1 x French/UTE socket outlets, shuttered, black, set at 35° · 1 x CAT6 RJ45 with 3.0 m data cable and RJ45 plug · 1 x USB 3.0 A socket with 3.0 m data cable and USB 3.0 A plug
928.010	· 1 x French/UTE socket outlets, shuttered, black, set at 35° · 1 x CAT6 RJ45 with 3.0 m data cable and RJ45 plug · 1 x HDMI socket with 3.0 m data cable and socket
928.026	· 1 x UK 5A individually fused, shuttered, black, set at 90° · 1 x USB double charger (5.2 V / 2.15 A)
928.035	· 1 x Swiss / T13, shuttered, black · 2 x CAT6 RJ45 with 3.0 m data cable and socket



Accessories

Article no. | Version

Hole saw		Diameter: 79 mm
928.900	· In wood/plastic; cutting depth up to 44 mm	
918.900	· Mounting tool for hole saw with centring drill	



Similar to photo

Article no. | Length | Version

Device supply cable, GST18/right-angled earthing contact plug			black
375.003	3.0 m	· Cable: H05VV-F 3G 1.5 mm <sup>2</sup>	
375.007	5.0 m	· End 1: Right-angled earthing contact plug / End 2: Wieland GST18i3 socket	

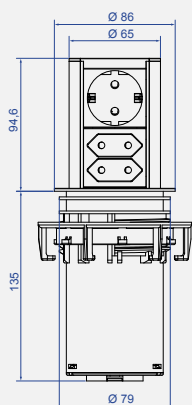

ELEVATOR fits in cut-outs 79 mm in diameter

100 mm high, 79 mm in diameter: With 3 socket outlets, ELEVATOR is a tiny yet impressive powerhouse. Simply press down with your thumb to open ELEVATOR. It is simply lowered again after use.



Dimensions in mm



## ELEVATOR COVER

The add-on for flexible installation

ELEVATOR COVER is the ideal add-on and screen for the ELEVATOR multiple-socket outlet. Two versions are available, both of which optimally encase each ELEVATOR multiple-socket outlet and add to the installation options.

BASE is the stainless steel look profile for installing under the kitchen wall cupboard;  
INSTALLATION is a housing for fitting inside the cupboard.

### The benefits at a glance

- Installation add-ons and screens suitable for the ELEVATOR power strip
- Mounted on the wall or in a corner
- Two versions available (in or below wall cupboard)
- Quick and easy to install
- Suitable for retrofitting



## ELEVATOR COVER

---

### ELEVATOR COVER

---

Article no. | Version

#### ELEVATOR COVER base

Height: 210 mm; diameter: 92 mm

Housing for mounting below kitchen wall cupboard

928.901 | · Stainless steel look surface



Illustration shows ELEVATOR power strip as example. Power strip not included.

#### ELEVATOR COVER installation

Dimensions: 127 x 127 x 150 mm

Housing for mounting inside kitchen wall cupboard

928.902 | · Stainless steel look (brushed) cover body  
· Plastic top



**NEW**

## SMART PLUG/FLAT PLUG

Flat plug for safety and convenience



The SMART PLUG/FLAT PLUG allows optimum use to be made of limited space behind cupboards, in the kitchen or office. The plug fits all common flush power socket systems. When plugged in, it lies neatly on the socket outlet and thereby allows power to be used in very tight spaces. When using the SMART PLUG/FLAT PLUG, devices or furniture can be located very close to the wall. When visible in the room, the flat shape makes a bold design statement.

Unwieldy plugs which are hard to release are instantly a thing of the past. Thanks to the smart lever function of the SMART PLUG with ejection mechanism, the plug can be pulled out with little effort, thereby ensuring convenient unplugging of devices.

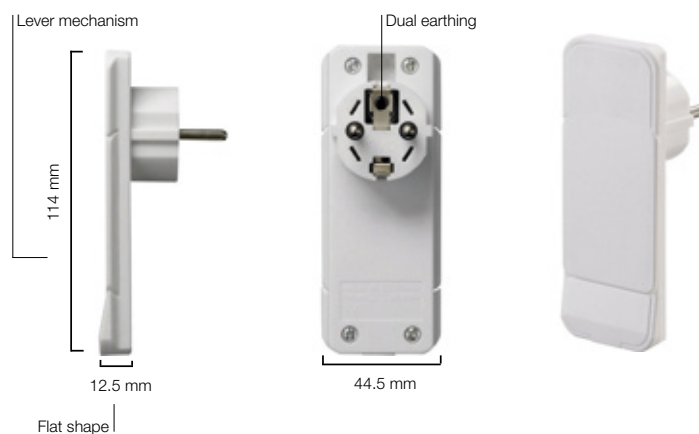

### The benefits at a glance

- Flat shape, design with straight lines
- Fits all common flush socket outlet systems
- Allows power to be used in very tight spaces, especially behind furniture
- Quality, VDE-approved flat plug
- Smart lever function means that little force has to be applied and plug can be loosened with ease
- Earthing contact plug CEE 7/7

# SMART PLUG/FLAT PLUG

## SMART PLUG

Flat plug with ejection mechanism

Article no. | Version

SMART PLUG	
Mounting plug – can be reconnected, without a cable	
933.008	<ul style="list-style-type: none"> <li>With lever and/or ejection mechanism, black</li> <li>VDE-approved</li> </ul>
933.009	<ul style="list-style-type: none"> <li>With lever and/or ejection mechanism, white</li> <li>VDE-approved</li> </ul>
With 1.5 m H05VV-F 3G 1.5/earthing contact coupling	
933.012	<ul style="list-style-type: none"> <li>With lever and/or ejection mechanism, black</li> <li>Components VDE-approved</li> </ul>
933.013	<ul style="list-style-type: none"> <li>With lever and/or ejection mechanism, white</li> <li>Components VDE-approved</li> </ul>
With 3.0 m H05VV-F 3G 1.5/earthing contact coupling	
933.010	<ul style="list-style-type: none"> <li>With lever and/or ejection mechanism, black</li> <li>Components VDE-approved</li> </ul>
933.011	<ul style="list-style-type: none"> <li>With lever and/or ejection mechanism, white</li> <li>Components VDE-approved</li> </ul>
With 1.6 m H05VV-F 3G 1.5/3-way tabletop power strip	
933.014	<ul style="list-style-type: none"> <li>With lever and/or ejection mechanism, black</li> <li>Components VDE-approved</li> </ul>
933.015	<ul style="list-style-type: none"> <li>With lever and/or ejection mechanism, white</li> <li>Components VDE-approved</li> </ul>

## FLAT PLUG

Flat plug without ejection mechanism

Article no. | Version

FLAT PLUG	
Mounting plug – can be reconnected, without a cable	
933.001	<ul style="list-style-type: none"> <li>Without lever and/or ejection mechanism, black</li> <li>VDE-approved</li> </ul>
933.002	<ul style="list-style-type: none"> <li>Without lever and/or ejection mechanism, white</li> <li>VDE-approved</li> </ul>
With 1.5 m H05W-F 3G 1.5/10 cm stripped/end sleeves	
933.003	<ul style="list-style-type: none"> <li>Without lever and/or ejection mechanism, black</li> <li>VDE-approved</li> </ul>
933.004	<ul style="list-style-type: none"> <li>Without lever and/or ejection mechanism, white</li> <li>VDE-approved</li> </ul>
With 1.5 m H05VV-F 3G 1.5/earthing contact coupling	
933.005	<ul style="list-style-type: none"> <li>Without lever and/or ejection mechanism, black</li> <li>Components VDE-approved</li> </ul>
933.006	<ul style="list-style-type: none"> <li>Without lever and/or ejection mechanism, white</li> <li>Components VDE-approved</li> </ul>
With 1.6 m H05VV-F 3G 1.5/3-way tabletop power strip	
933.007	<ul style="list-style-type: none"> <li>Without lever and/or ejection mechanism, white</li> <li>Components VDE-approved</li> </ul>





## CASIA

### Elegant use of space in the modern kitchen

The universal power strip is an efficient solution providing an easy-to-access power connection in the kitchen. The power strip can be mounted in a corner or on the wall.







The cover surface with stainless steel look finish has a timeless design, suitable for any kitchen. The multiple-socket outlet is available in different variants – for example with a toggle switch or USB double charger .

#### The benefits at a glance

- Supplied with cover for individual adjustment of installation height
- Quick and flexible in use
- For wall or corner mounting
- Suitable for retrofitting
- Timeless design
- Secure installation

CASIA power strip

Article no. | Version

CASIA		Length: 458 – 580 mm
Stainless steel look profile		
Power input: 2.0 m H05VV-F 3G 1.5 mm <sup>2</sup> with mounting plug, included		
923.006	· 4 x socket outlet with earthing contact, shuttered, black	
923.007	· 4 x socket outlet with earthing contact, shuttered, with 1 x rocker switch, black	
923.008	· 4 x socket outlet with earthing contact, shuttered, with 1 x rocker switch, black · 1 x USB double charger	
923.010	· 4 x French/UTE socket outlet, shuttered, black	
923.011	· 4 x French / UTE socket outlet, shuttered, with 1 x rocker switch, black	
923.012	· 4 x French / UTE socket outlet, shuttered, with 1 x rocker switch, black · 1 x USB double charger	



CASIA

Quick and flexible to use, CASIA can be mounted on the wall or in a corner.

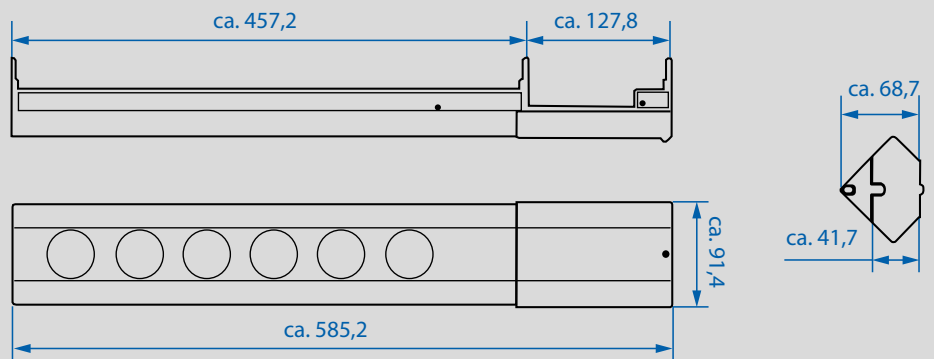

Dimensions in mm



## POWER FRAME

### Compact and efficient

POWER FRAME is the compact solution for integrated and easily accessible power connections. Combining compact dimensions with high-quality timeless design, POWER FRAME opens up virtually unlimited application options.

The power strip can be simply clicked into the built-in frame from below.

#### The benefits at a glance

- Suitable for retrofitting
- Compact dimensions
- Versatile in application
- Quickly installs complete power strips
- Multitude of configuration options

POWER FRAME built-in frame





Article no. | Version

POWER FRAME 3-way built-in frame		External dimensions: approx. 241 x 73 mm
317.001	· Stainless steel	
915.000	· Black similar to RAL 9005	
915.001	· White similar to RAL 9010	



POWER FRAME power strips

Article no. | Version

POWER FRAME Power strips		Length: approx. 220 mm
Anodised aluminium profile; fixed connection with power input 2.0 m H05VV-F 3G 1.5 mm <sup>2</sup> with end sleeves and included mounting plug		
916.1192	· 3 x socket outlets with earthing contact, shuttered, black, set at 35°	
916.111	· 3 x French/UTE socket outlets, shuttered, black, set at 35°	
916.1193	· 2 x socket outlets with earthing contact, shuttered, black, set at 35° · 1 x USB double charger (5.2 V / 2.15 A)	
916.112	· 2 x French / UTE socket outlet, shuttered, black, set at 35° · 1 x USB double charger (5.2 V / 2.15 A)	

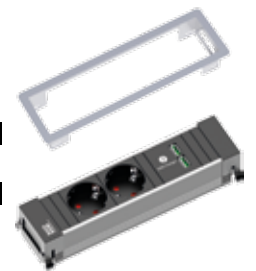

 Also available in other configurations and country versions



Configure your individual BACHMANN product at [www.bachmann.com](http://www.bachmann.com)

The power strip is simply clicked into the built-in frame and the power cable plugged in on the rear.

- Built-in frame for work surface thicknesses: from 10 mm
- Installation depth (of built-in frame): approx. 36 mm
- Corner radius for flush mounting: R5
- Total installation depth (with cables): approx. 70 mm

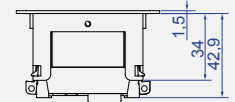
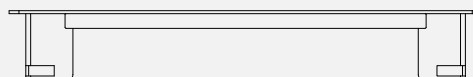
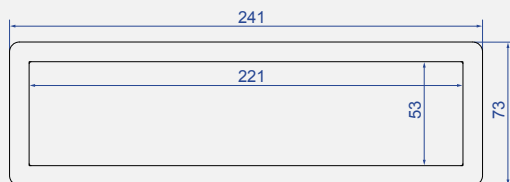
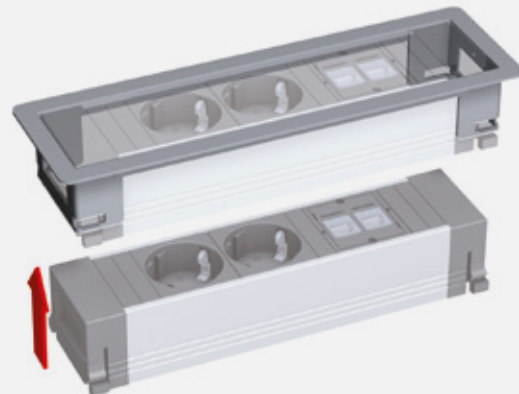

Dimensions in mm





## POWER FRAME COVER

Who'd have thought power could be so elegant?

The compact POWER FRAME has evolved into the POWER FRAME COVER with an elegant and attractive aluminium cover, designed especially for stylish kitchen environments and with the added bonus of protection from dust and dirt.

### The benefits at a glance

- Design piece made from anodised aluminium
- Suitable for retrofitting
- Power and data can be accessed from all sides
- Dust protection
- Compact dimensions
- Versatile in application
- Quickly installs complete power strips
- Multitude of configuration options

As awarded by The Chicago Athenaeum: Museum of Architecture and Design.



## POWER FRAME COVER

## POWER FRAME COVER





Article no. | Version

POWER FRAME COVER 3-way		Dimensions approx. 255 x 87 x 8 mm
3-way aluminium flap for gluing into the worktop		
915.500	· Aluminium flap	
915.501	· Inox (similar to MAS0802000), painted aluminium	
915.503	· White (similar to RAL 9010), painted aluminium	
915.022	· Black (similar to E1/C35), anodised and brushed aluminium	



## POWER FRAME power strips

Article no. | Version

POWER FRAME Power strips		Length: approx. 220 mm
Anodised aluminium profile; fixed connection with power input 2.0 m H05VV-F 3G 1.5 mm <sup>2</sup> with end sleeves and included mounting plug		
916.1192	· 3 x socket outlet with earthing contact, shuttered, black, set at 35°	
916.111	· 3 x French / UTE socket outlet, shuttered, black, set at 35°	
916.1193	· 2 x socket outlet with earthing contact, shuttered, black, set at 35° · 1 x USB double charger (5.2 V / 2.15 A)	
916.112	· 2 x French / UTE socket outlet, shuttered, black, set at 35° · 1 x USB double charger (5.2 V / 2.15 A)	



 Also available in other configurations and country versions



Configure your individual BACHMANN product at [www.bachmann.com](http://www.bachmann.com)

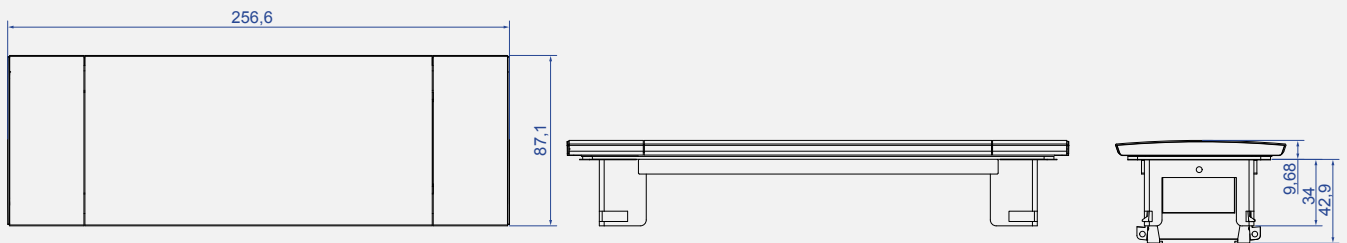

Dimensions in mm





## CONI

### Integrated functionality

CONI brings flexibility to the work surface as it enables free, individual access to power. CONI's minimal installation depth provides sufficient space, even if installed near the edge. A wide range of standard surface finishes also provides the freedom to design.

When not in use, CONI fits neatly into the work surface. When you need power, data or media, simply open the cover, plug into a socket and close the cover again. The integrated brush insert prevents the cables from jamming. The harmonious appearance of an even surface is retained.

With CONI you are free to decide how the socket outlets are configured because the power strip can be quickly replaced without any tools.

#### The benefits at a glance

- Integrated into your desktop or tabletop
- Suitable for retrofitting
- Minimum built-in depth, robust frame design
- Integrated brush insert for closing once cables have been connected
- Complete power strip can be quickly interchanged

CONI built-in frame

Article no. | Version

<b>CONI short</b>	<b>Stainless steel</b>
911.004	· Ground stainless steel, with integrated brush strip (black)

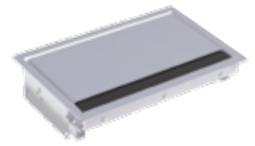

CONI power strips

Article no. | Version

<b>3 x power socket outlet</b>	<b>Length: approx. 217 mm</b>
Anodised aluminium profile; power input: 0.2m cable and GST18i3 plug	
333.1007	· 3 x socket outlets with earthing contact, shuttered, black, set at 35°



<b>2 x power socket outlet + 1 x USB double charger (5.2 V / 2.15 A)</b>	<b>Length: approx. 217 mm</b>
Anodised aluminium profile; power input: 0.2 m cable and GST18i3 plug	
912.0156	· 2 x socket outlets with earthing contact, shuttered, black, set at 35° · 1 x USB double charger (5.2 V / 2.15 A)



**!** Also available in other configurations and country versions

Supply cable

Article no. | Length | Version

<b>Device supply cable, GST18/right-angled earthing contact plug</b>	<b>black</b>	
375.075	2.0 m	· Cable: H05VV-F 3G 1.5 mm <sup>2</sup> · End 1: Right-angled earthing contact plug; end 2: Wieland GST18i3 socket

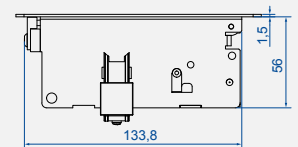
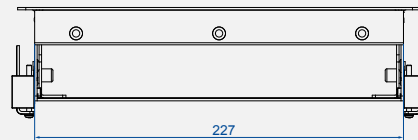
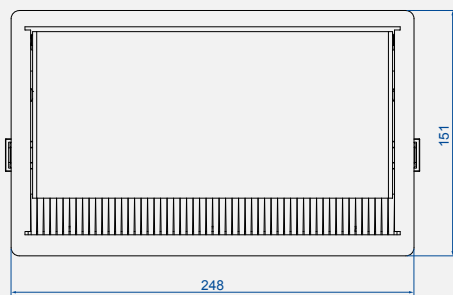

Dimensions in mm





## LIFT

### High-tech in motion

LIFT is the totally practical combination of sophisticated looks and high-precision mechanical design. The unit is recessed neatly in the worktop when not in use. Simply touch to raise out of the work surface ready for docking on all four sides. Once you have finished using the LIFT unit, simply push it back into its initial recessed position by hand.

This highly compact unit needs a drill hole only 140 mm in diameter for installation. Built-in depth both open and closed is just 195 mm.

#### The benefits at a glance

- Simply touch to raise
- Suitable for retrofitting
- Attractive looks all round
- Access points on 4 sides
- Incredibly compact dimensions
- Low built-in depth
- 4 plug-in units on one height unit

Enclosure colour black + silver

Article no. | Version

**LIFT black, 4 x power socket outlet**

Enclosure colour black; power input: 0.5 m cable and GST18i3 plug

- |         |  |
|---------|--|
| 904.000 | · 4 x socket outlets with earthing contact, shuttered, black, set at 35° |
| 904.004 | · 4 x French/UTE socket outlet, shuttered, black                         |



Article no. | Version

**LIFT silver, 4 x power socket outlet**

Enclosure colour silver; power input: 0.5 m cable and GST18i3 plug

- |         |  |
|---------|--|
| 904.008 | · 4 x socket outlets with earthing contact, shuttered, black, set at 35° |
| 904.012 | · 4 x French/UTE socket outlet, shuttered, black                         |

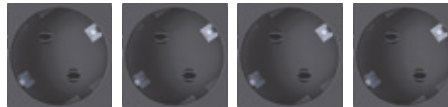

**!** Also available in other configurations and country versions

**Hole saw**

**Diameter: 140 mm**

For fitting the LIFT

- |         |  |
|---------|--|
| 904.900 | · Hole saw for clamping<br>· 140 mm diameter     |
| 918.900 | · Mounting tool for hole saw with centring drill |



Similar to photo

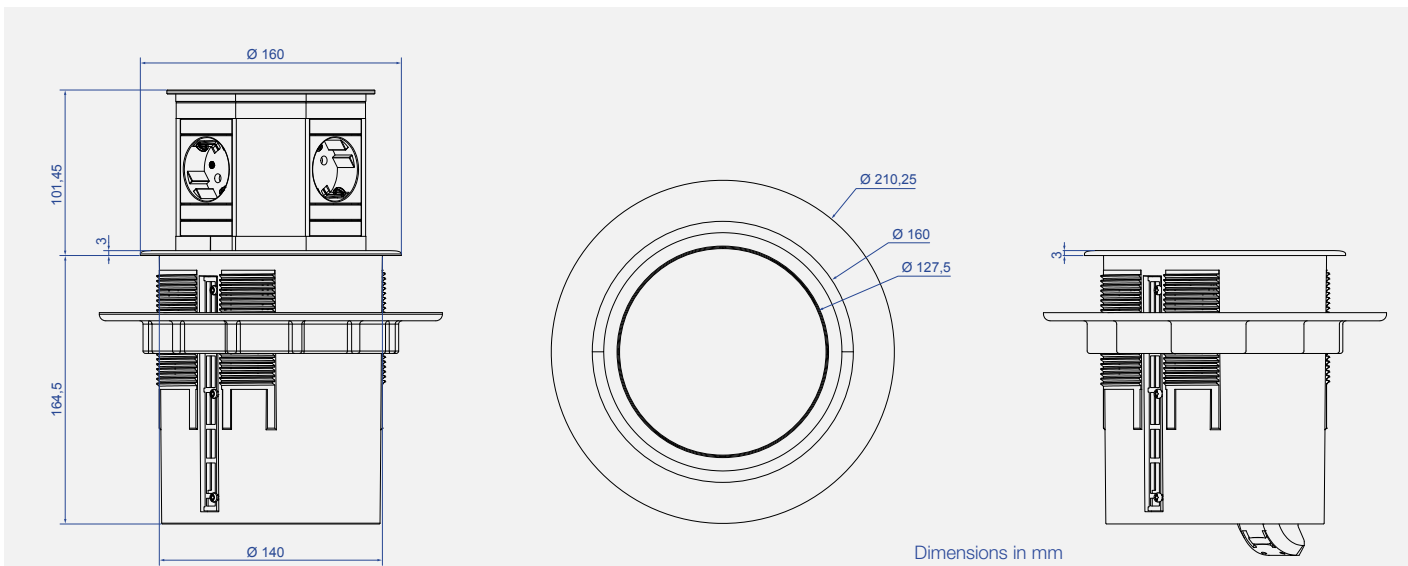



## Kitchen connection box

The universal accessory for connecting hob and oven

Article no. | Version



### Kitchen connection box

Grey, with screw-mounting eyes, connected load up to 10 kW

H05VV-F 5G 2.50 mm<sup>2</sup> for cooker socket

H05VV-F 4G 2.50 mm<sup>2</sup> for hob

H05VV-F 3G 1.50 mm<sup>2</sup> with socket outlet with earthing contact for oven



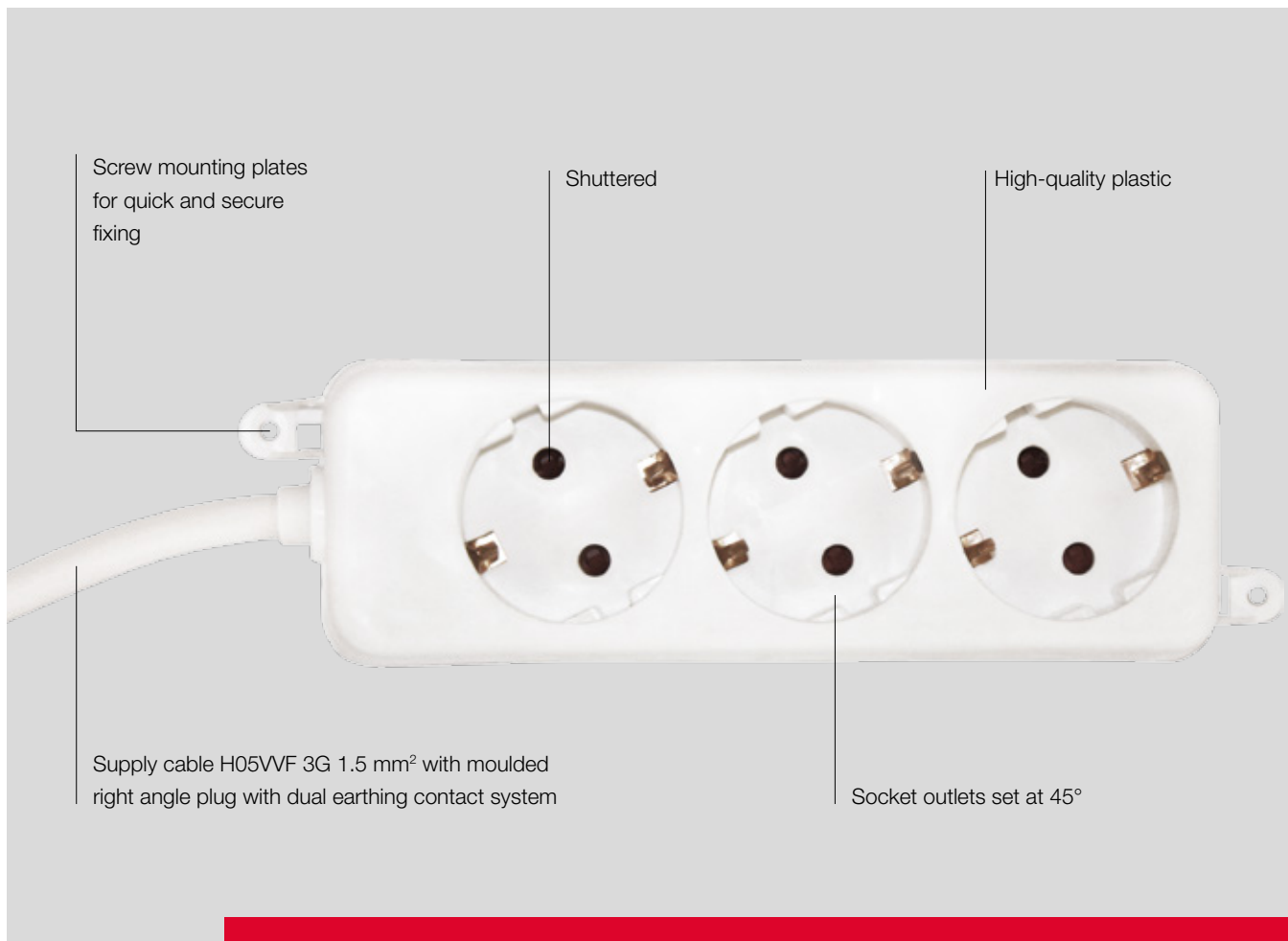

923.000	<ul style="list-style-type: none"> <li>· 2 m kitchen connection box</li> <li>· Cooker connection socket 2.0 m; hob 2.0 m and oven 2.0 m</li> </ul>
923.001	<ul style="list-style-type: none"> <li>· 5 m kitchen connection box</li> <li>· Cooker connection socket 2.0 m; hob 5.0 m and oven 5.0 m</li> </ul>
923.0011	<ul style="list-style-type: none"> <li>· Kitchen connection box 5 m PLUS</li> <li>· Cooker connection socket 5.0 m; hob 5.0 m and oven 5.0 m</li> </ul>
923.002	<ul style="list-style-type: none"> <li>· 10 m kitchen connection box</li> <li>· Cooker connection socket 2.0 m; hob 10.0 m and oven 10.0 m</li> </ul>

### The benefits at a glance



- No need to fit additional sockets
- The existing cooker socket can still be used
- Saves costs as no need to fit sockets later
- Rewirable WAGO® terminals
- Low built-in depth (approx. 34 mm)
- Can also be used in combination with an induction cooker



## SELLY + SMART

Article no.	Version	Unit
<b>SELLY 3 x socket outlet with earthing contact with screw mounting plates</b>		<b>Dim.: approx. 160 x 50 x 40 mm</b>
3 x socket outlet with earth contact, set at 45°, shuttered		
Supply cable: H05VV-F 3G 1.50 mm <sup>2</sup> with right-angled earthing contact plug		
387.274S	· 1.5 m supply cable, white	20 unit 
387.275S	· 3.0 m supply cable, white	20 unit 
<b>SELLY 3 x socket outlet with earthing contact without screw mounting plates</b>		<b>Dim.: approx. 160 x 50 x 40 mm</b>
387.270S	· 1.5 m supply cable, white	20 unit 
387.271S	· 3.0 m supply cable, white	20 unit 
<b>SELLY 6 x socket outlet with earthing contact without screw mounting plates</b>		<b>Dim.: approx. 275 x 50 x 40 mm</b>
6 x socket outlet with earth contact, set at 45°, shuttered		
Supply cable: H05VV-F 3G 1.50 mm <sup>2</sup> with right-angled earthing contact plug		
381.241S	· 1.5 m supply cable, white	20 unit 



Article no.	Version	Unit
<b>SMARTLINE 3 x French / UTE</b>		<b>Dimensions: approx. 185 x 56 x 41 mm</b>
Rewirable, without switch		
3 x French / UTE socket outlet, shuttered		
388.270F	· 1.5 m supply cable, white	20 unit 
388.271F	· 3.0 m supply cable, white	20 unit 



Cooker connecting cable with end sleeves PVC, 70 °C

Also available in 25 m and 50 m rings 

- End 1: 50 mm stripped with end sleeves
- End 2: 110 mm stripped with end sleeves, 140 mm green/yellow protective conductor



Article no.	Length	Colour	Unit
<b>H05VV-F 5G 1.50 mm<sup>2</sup></b>			<b>Diameter: approx. 9.5 mm</b>
Without packaging			
116.270	1.5 m	· White	50 unit
116.271	2.0 m	· White	50 unit
116.272	3.0 m	· White	30 unit
Individually packed			
116.280	1.5 m	· White	50 unit
<b>H05VV-F 3G 2.50 mm<sup>2</sup></b>			<b>Diameter approx. 10.1 mm</b>
Without packaging			
118.270	1.5 m	· White	50 unit
<b>H05VV-F 5G 2.50 mm<sup>2</sup></b>			<b>Diameter: approx. 11.3 mm</b>
Without packaging			
119.270	1.5 m	· White	50 unit
119.271	2.0 m	· White	30 unit
119.272	3.0 m	· White	20 unit
Individually packed			
119.280	1.5 m	· White	1 unit
119.281	2.0 m	· White	1 unit
119.283	5.0 m	· White	1 unit

Cooker connecting cable with fork-type lugs PVC, 70 °C

Also available in 25 m and 50 m rings 

- End 1: 50 mm stripped with end sleeves
- End 2: 110 mm stripped with fork-type lugs M5, 140 mm green/yellow earth conductor



Article no.	Length	Colour	Unit
<b>H05VV-F 5G 2.50 mm<sup>2</sup></b>			<b>Diameter: approx. 11.3 mm</b>
Without packaging			
119.274	2.0 m	· White	30 unit
119.203	5.0 m	· White	30 unit

Cooker connection socket 16 A/380 V~



- Duroplast version for surface or flush mounting
- Quick and easy to connect thanks to spacious terminal area
- Clamping range: 0.75–2.5 mm<sup>2</sup> for 55 mm wall socket

Article no.	Colour	Unit
<b>Cooker connection socket</b>		
16A/380V~		
· For 55 mm wall boxes / height 23 mm		
190.270	· White	20 unit

Device connection socket 16 A/380 V~



- Thermoplastic version for concealed wiring mounting
- Easy to fit with removable terminal block and snap-lock cover
- With screw terminal 5 x 2.50 mm<sup>2</sup> and strain relief
- For 55 mm wall socket/height 14 mm

Article no.	Colour	Unit
<b>Appliance junction box</b>		
190.271	· White	20 unit



Earthing contact extension cable, 16 A/250 V~, PVC, 70 °C

- End 1: Right-angled earthing contact with dual earthing contact system, moulded
- End 2: Earthing contact coupling, moulded, with extra shuttering in coupling

Article no.	Version	Unit
<b>Earthing contact extension, white, cable: H05VV-F 3G 1.50 mm<sup>2</sup></b>		
341.200S	· 2 m	50 unit
341.201S	· 3 m	50 unit
341.202S	· 5 m	30 unit
341.203S	· 10 m	20 unit



Spiral earthen contact extension cable, PVC, elongation factor 1:4, 70 °C

- End 1: Central plug with dual earthing contact system, moulded
- End 2: Earthing contact coupling, moulded

Article no.	Coil length	Operating length	Version	Unit
<b>Spiral earthen contact extension cable, PVC</b>				
H05VV-F 3G 1.50 mm <sup>2</sup> , diameter approx. 8.4 mm, CID: approx. 10 mm, CED: approx. 27 mm				
672.280	500 mm	2,000 mm	· White	20 unit
672.281	1,000 mm	4,000 mm	· White	20 unit



Earthing contact supply cable, PVC, max. 16 A/250V~, 70 °C

- End 1: Right-angled earthing contact with dual earthing contact system, moulded
- End 2: 30 mm stripped with end sleeves

Article no.	Length	Colour	Unit
<b>H05VV-F 3G 1.50 mm<sup>2</sup>, diameter approx. 8.0 mm</b>			
Without packaging			
305.274	2.0 m	· White	50 unit
305.275	3.0 m	· White	50 unit
305.276	5.0 m	· White	30 unit



Article no.	Version	Unit
<b>Flanged earthing contact plug/angled</b>		
H05VV-F 3G 1.5 mm <sup>2</sup>		
· Unbreakable construction, with side entry		
911.270	· White	40 unit



Article no.	Version	Unit
<b>Earthing contact coupling</b>		
H05VV-F 3G 1.5 mm <sup>2</sup>		
· Small, break-proof design made from plastic		
912.270	· White	50 unit



Article no.	Version	Unit
<b>Earthing contact mounting plug</b>		
H05VV-F 3G 0.75/1.0/1.5 mm <sup>2</sup>		
· With dual earthing contact system and nickel-plated contacts, e.g. Germany and France		
· Small, break-proof design with separate strain relief, no parts that can be lost		
910.200	· White	10 unit



Article no.	Version	Unit
<b>Lamp holder, pre-wired</b>		
E 27		
· 60W plastic E 27 holder; 0.2 m H03VV-F2x 0.75 mm <sup>2</sup> ; black; supplied in quantities of 20 only		
641.170	· With 2-pin terminal block	20 unit



Article no.	Version	Unit
<b>Overload protection-power strip type 8110</b>		
2 x 230V~, 50Hz/16 A		
924.164	· For connecting two devices with high power consumption (e.g. washing machines and driers)	20 unit
	· 1.5 m connector cable with plug	
	· 1 socket outlet with automatic cut-out, power dependent, 1 socket outlet for continuous power	
	· Screw-on	









**BACH  
MANN**

**Bachmann GmbH & Co. KG**

Ernstthaldenstr. 33 / 70565 Stuttgart / Germany

Telephone +49 711 866 02-0 / Fax +49 711 866 02-34

[info@bachmann.com](mailto:info@bachmann.com)/[www.bachmann.com](http://www.bachmann.com)